

Scintillation Counter

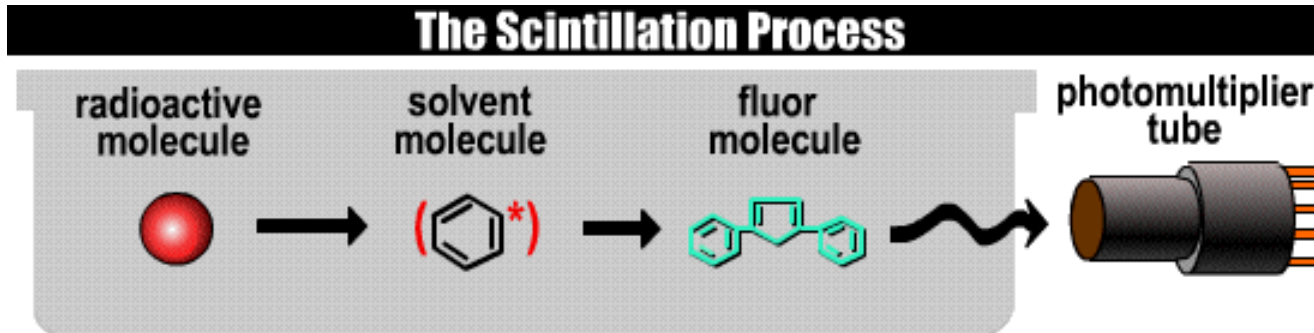

- Scintillation Cocktail contains solvent and fluor (or solute) molecules.
- Solvent is good at capturing energy of β -particle (electron), but does not produce light.
- A fluor molecule enters an excited state following interaction with excited solvent.
- The excited fluor molecule decays to ground state by emitting light (usually in blue wavelength)
- Blue light is detected by photomultiplier tube (usually two PMT are used to minimize PMT errors).

β -Energy and Light Intensity

Stronger β emitters generate stronger pulses of light, so that ^3H , ^{14}C , and ^{32}P can all be distinguished and counted at the same time.

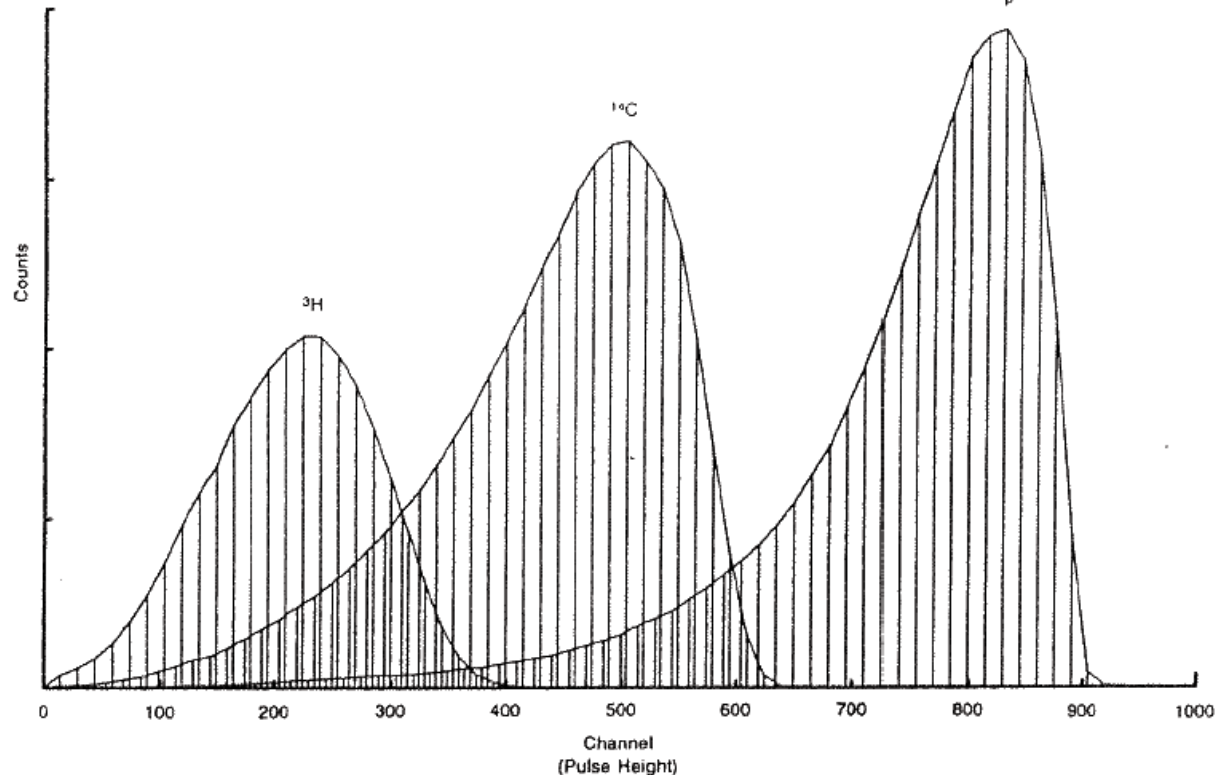
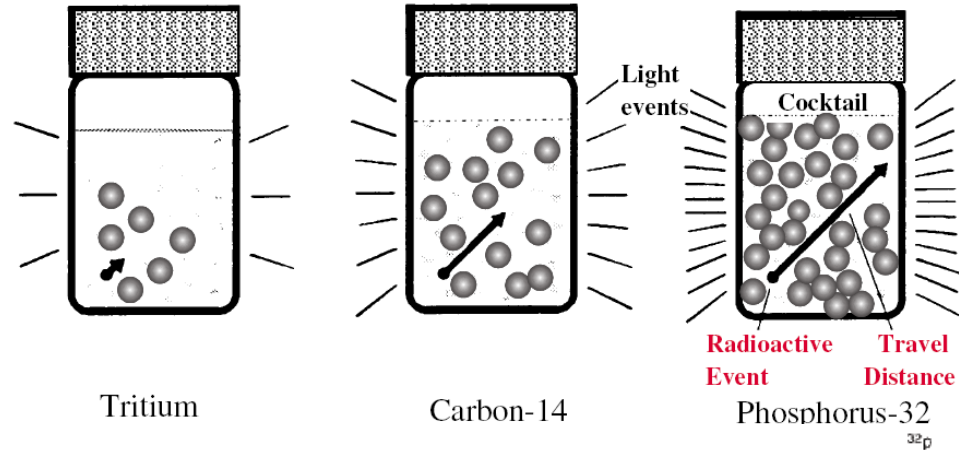

Quenching

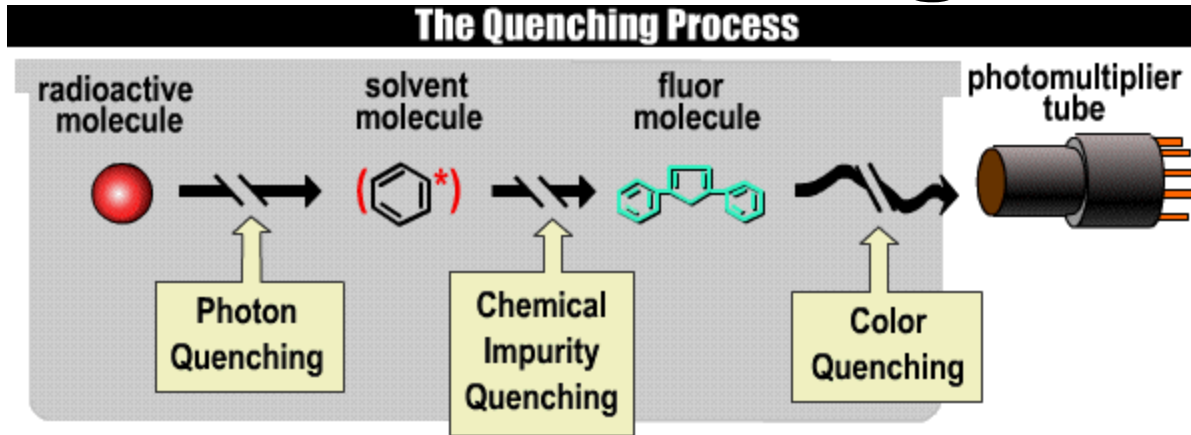

Effects of Quenching

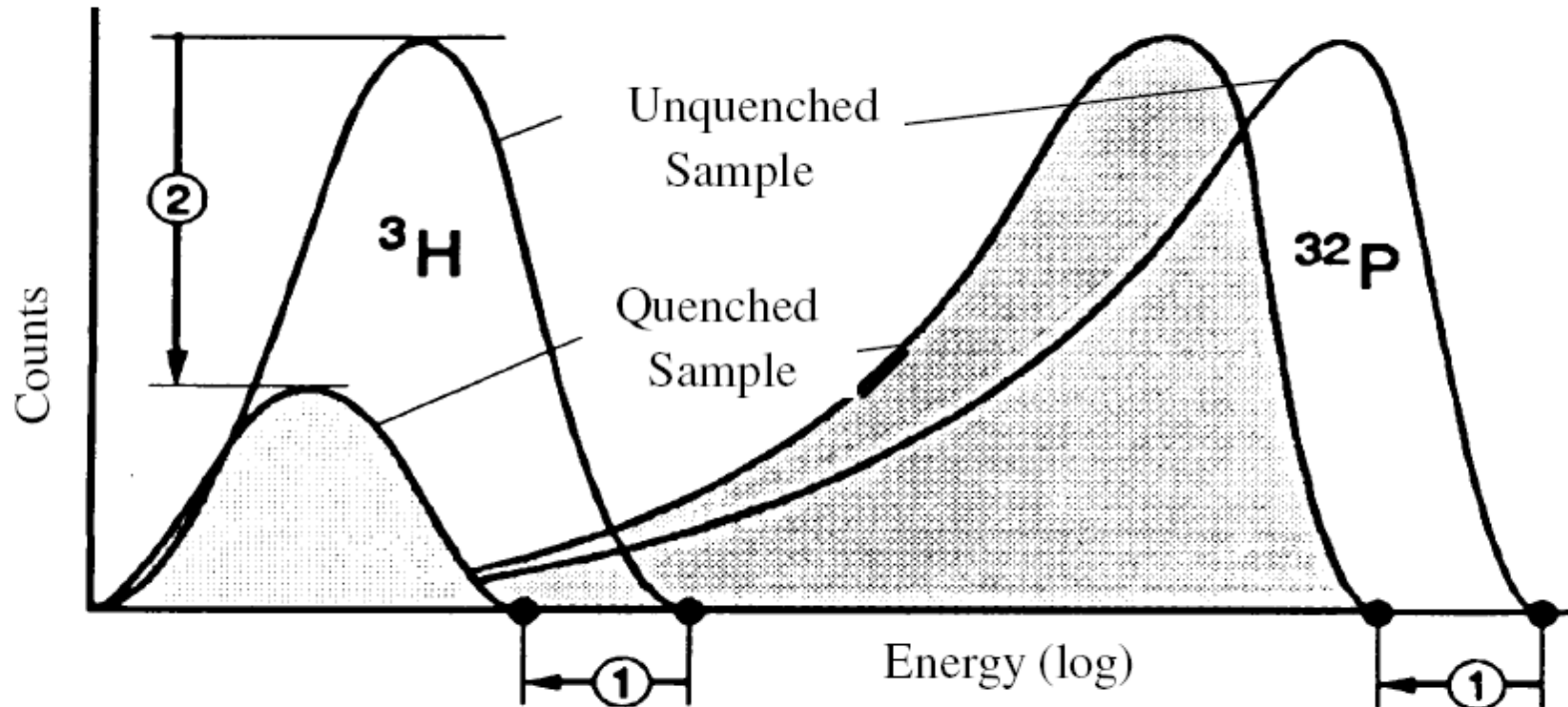

Beckman's H#

Compton electrons

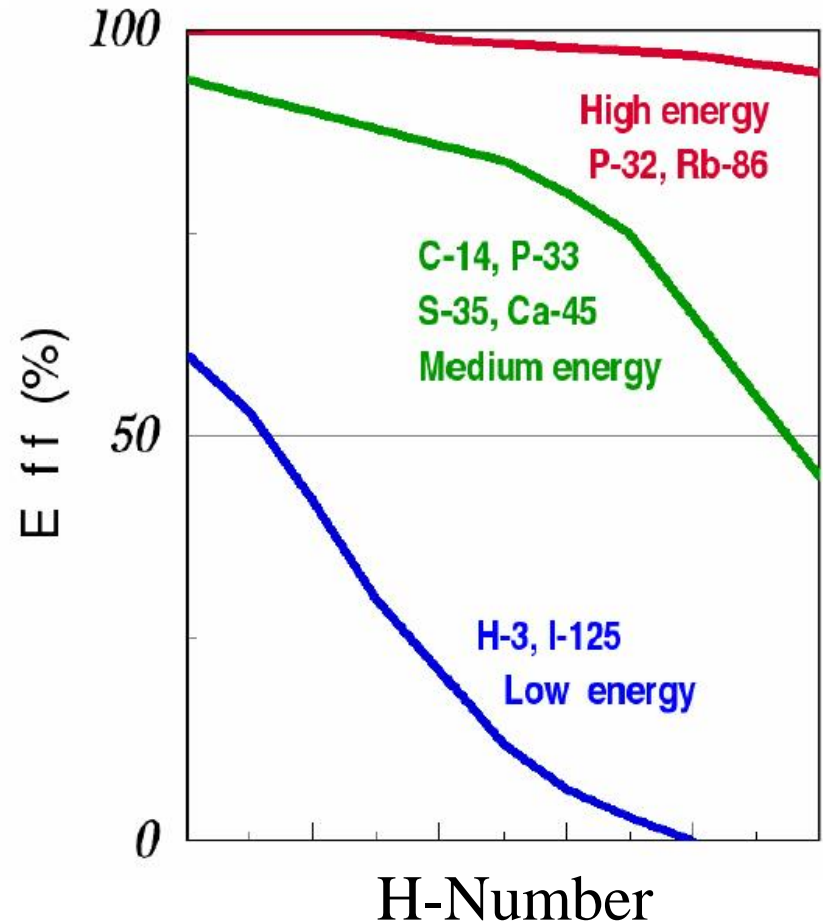
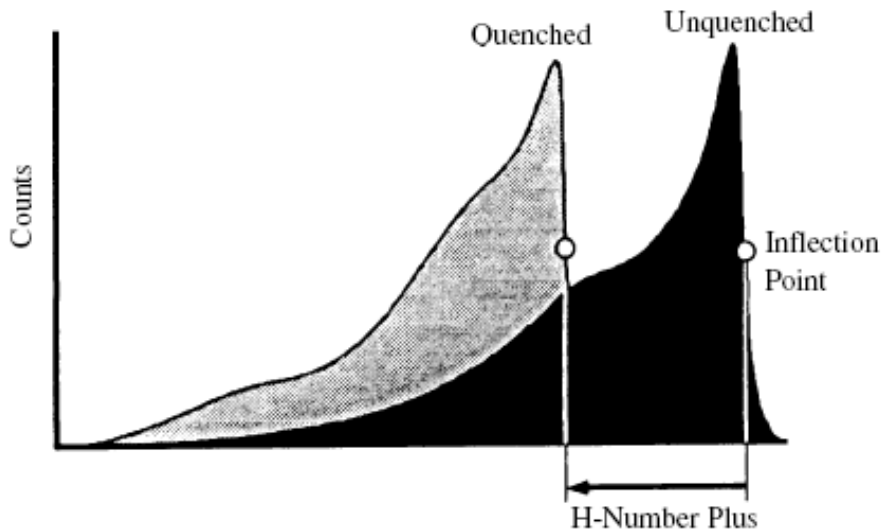
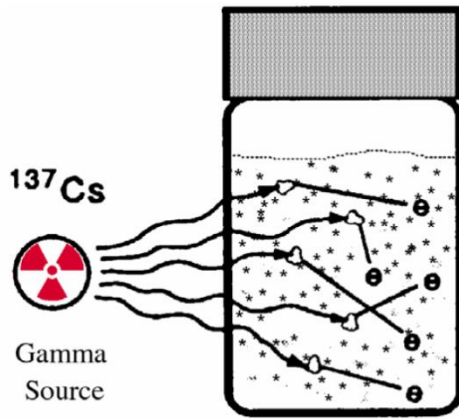

The larger the H number the greater the quenching

HideX 300 SL

Triple to Double Coincidence Ratio (TDCR) method

(see http://www.nucleide.org/ICRM_LSCWG/icrmtdcr.htm)

$$\frac{\epsilon_T}{\epsilon_D} = \frac{\int_0^{E_{max}} S(E) \left(1 - e^{-\frac{\nu m}{3}}\right)^3 dE}{\int_0^{E_{max}} S(E) \left(3\left(1 - e^{-\frac{\nu m}{3}}\right)^2 - 2\left(1 - e^{-\frac{\nu m}{3}}\right)^3\right) dE}$$

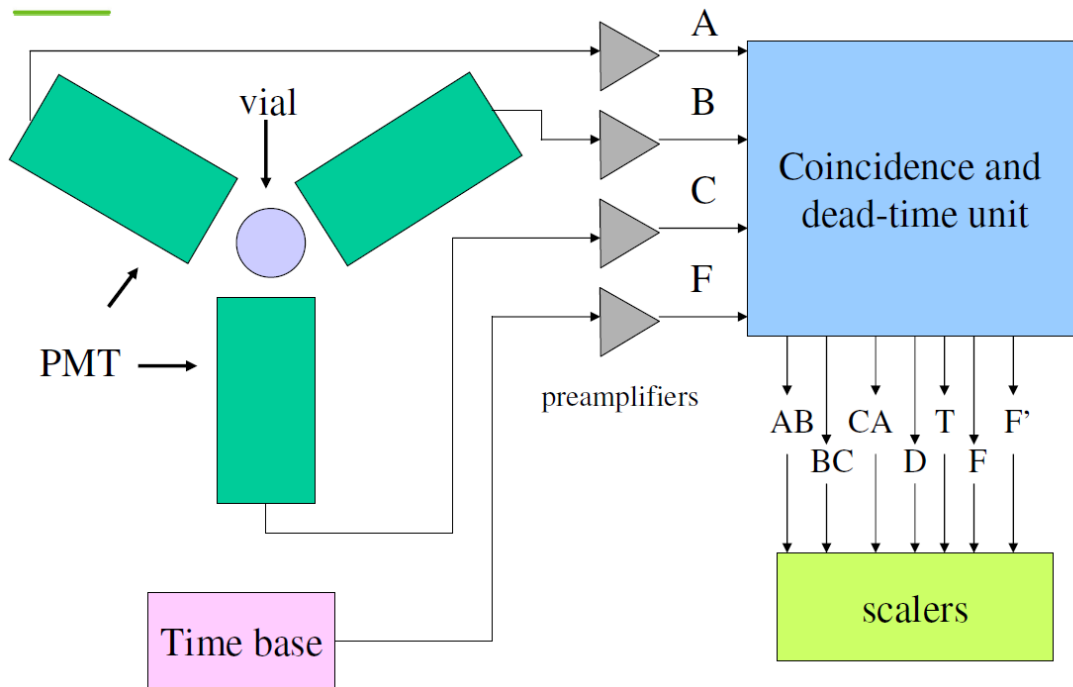

$$m = \alpha \int_0^E \frac{dE}{1 + kB \frac{dE}{dx}}$$

$$\frac{T}{D} = \frac{\epsilon_T(\nu\alpha)}{\epsilon_D(\nu\alpha)} = TDCR$$

Measured